



PoE technology

Part 2 - Market and applications

By Jean-Jacques Sage, Engineering, Technical Support & Services Director

Introduction

PoE technology is used to simultaneously transmit power and data using an Ethernet cable. Standardised for almost 20 years, it has developed in commercial buildings thanks to IP convergence. Today, in companies the majority of telephone sets, Wifi access points and video surveillance cameras use this technology. This plebiscite can be explained by the simplicity of implementation and the economic aspect of such an infrastructure: a single cable for data and energy.

A first white paper introduced you to the main characteristics of PoE technology and normative bases. This second document presents the penetration of this technology by application and geographic area.

Reminder of PoE technology

PoE technology is used to power remotely connected devices and simultaneously transmit data using an Ethernet cable consisting of 4 pairs of twisted copper wires.

The standard defined by the IEEE currently allows to inject up to 90W to power a remote device (camera, phone, Wifi access point, etc.) with a maximum range of 100 meters. The compatible Ethernet cables carry data at the same time, at up to 10 Gbit/s depending on cable type and equipment used.

The principle of PoE power supply is based on the use of twisted copper pairs of the Ethernet cable to power from the source called PSE (Power Sourcing Equipment), the remote equipment called PD (Power Device). The IEEE 802.3 standard sets the maximum distance of the Ethernet cable at 100 meters to take into account losses caused by the resistivity of the cable.



In-building PoE applications

Against the backdrop of tighter environmental regulation, particularly in terms of energy consumption, manufacturers are seeking to diversify by offering more services to their customers to reduce their environmental footprint (cf. green building) and enhance the safety of buildings. We talk about Smart Building or Smart Home.

In this context, PoE technology is very well placed to meet all these needs. Indeed, to develop these services, it is necessary to connect an increasing number of equipments and objects that require supervision and maintenance. The phrases Building Management System (BMS) and Centralised Technical Management (CTM) are used to describe the management of this building, which is becoming a real telecom network. The issues are complex and similar to those of information systems (scalability, safety, interoperability): the use of structured cabling based on 4-pair Ethernet cable and the evolution of BMS/CTM applications towards IP now allow centralised management of all building applications.

Smart building

The main uses are :

- Introduction of Type 3 and Type 4 for Energy savings: water and energy management with smart metering,

- Safety: 24/7 building supervision (video surveillance, alarm settings), fire and intrusions detection, elevators management,
- Comfort: management of the lights, heating and air conditioning, predictive and preventive maintenance of the building,
- Efficiency: management of indoor mobile coverage, meeting rooms, digital signage and parking spaces.

Lighting management

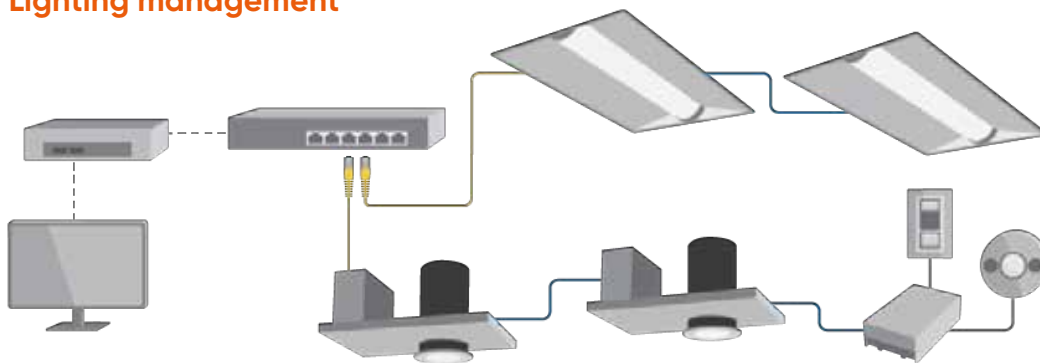

With its network of smart sensors (presence, luminosity, etc.), the building is fully meshed and sends essential information to adapt light to the needs of users. This helps saving money and developing an infinity of value-added services for users, such as remote control of lights using a supervision platform.

In the United States, the use of PoE technology for lighting management is widespread. In Europe, LED light is still mostly grid-powered, but several emblematic projects have highlighted the advanced features and potential benefits for users and managers.

Indoor mobile coverage

Cisco's «VNI Mobile» study shows that mobile data traffic is exploding, reaching 11 exabytes per month in 2017, twice as much as in 2015, rising up to 49 exabytes in 2021. Given that 80% of 4G/LTE traffic is generated inside buildings, indoor mobile coverage is becoming a major concern. With the development of 5G networks and the increase in the frequency used (>3.5GHz), the propagation of waves indoors is limited by the structure of the building itself. Modern buildings known as High Environmental Quality buildings are «airtight» to wave propagation due to the general use of materials such as concrete, multi-layer glass walls and metal. As a result, it becomes necessary to add an indoor antennas array. These antennas are connected to their central unit (RHUB) by Ethernet cables of at least Category 6A, these cables carry the radio signal and the power.

Today, all telecom equipment manufacturers offer an indoor mobile coverage solution, using Ethernet cabling and PoE technology:

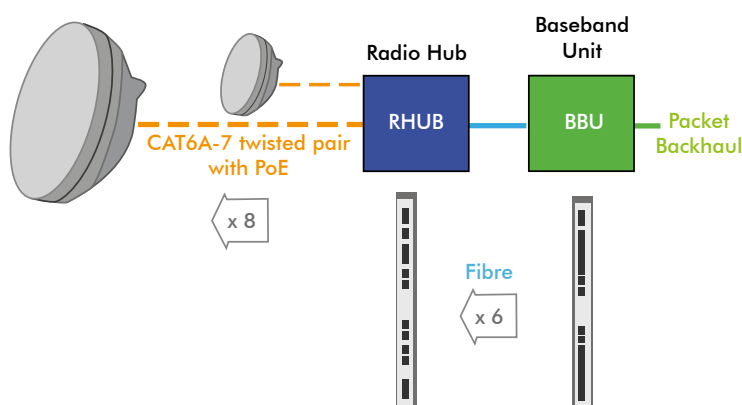

Off-building PoE applications

For many years, video security networks have benefited from developments related to the use of digital transmissions. As the equipments is now IP-native, transmissions are mainly done over Ethernet cable or optical fibre. Simplifying the installation of this equipments, PoE has naturally established itself as the major power supply protocol for these networks.

Microwave solutions have long been the most common solution for designing backhaul networks. In 2022, high-capacity radio sites will require backhaul networks of around 1Gbit/s; by 2025, requirements will be 3 to 5Gbit/s. Microwave technology perfectly fits to these developments with capacities of 10Gbit/s and low latency.

A study lead by ABI Research shows the predominance of microwave networks in mobile networks.

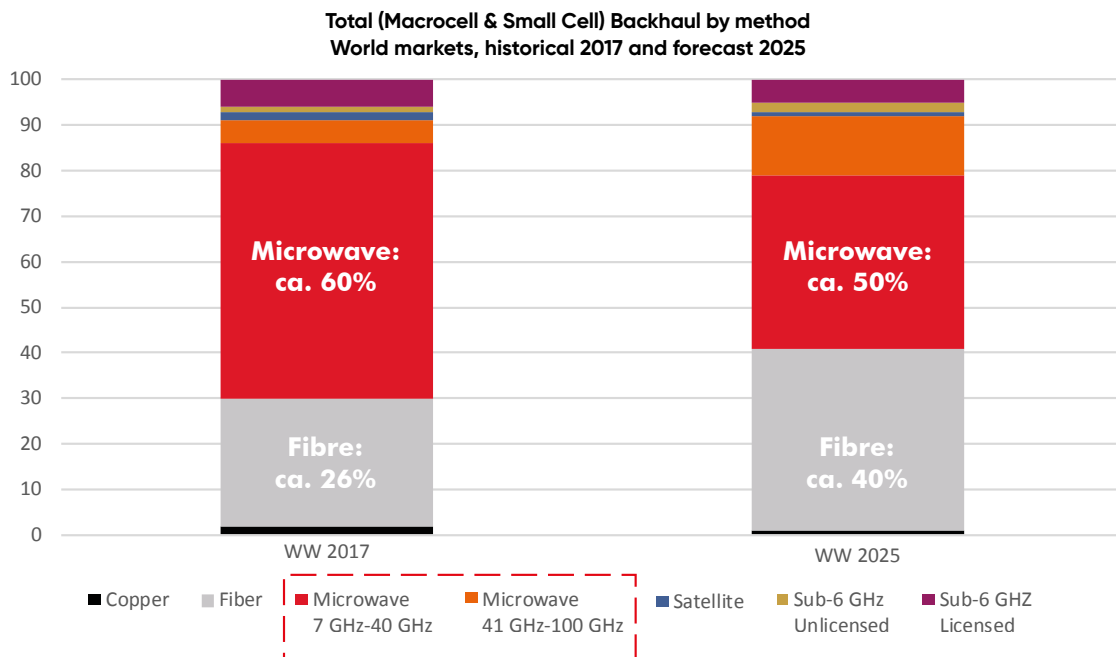

For a microwave backhaul, to simplify the installation of cables and equipment, the Outdoor Distribution Unit close to the antenna is supplied with data and power by a single Ethernet cable.

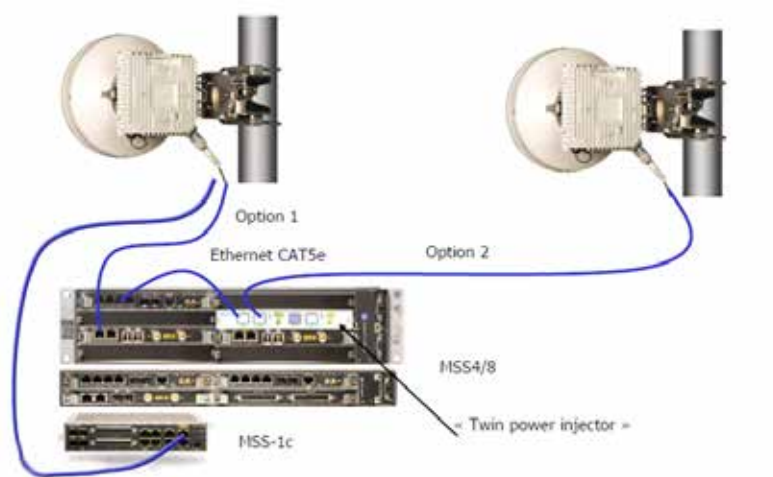

PoE market

The global PoE market is very dynamic on all continents and for all types of applications. LED lighting, IP telephony and Wifi access points are the main applications, generating significant revenues for the PoE switches and interfaces industry.

Global consumption revenue market share (%) by applications in 2017

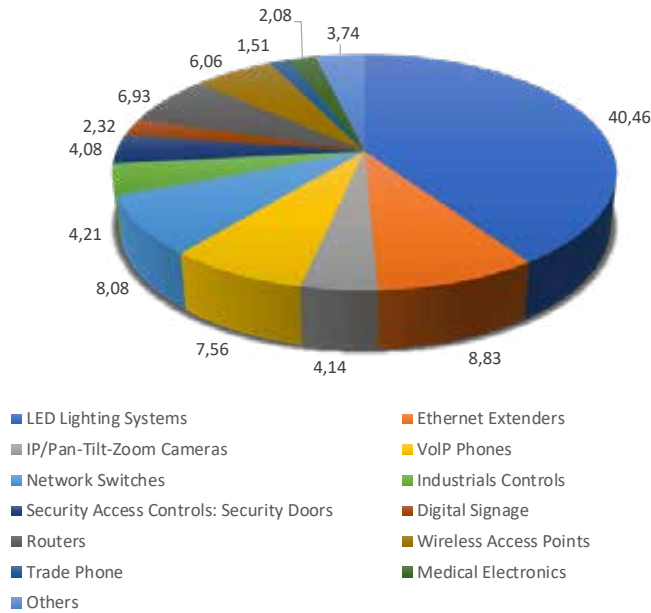

Source : Apex Market Research

North America market is showing strong growth dynamics, supported by the development of LED lighting.

North America PoE revenue (USD Millions) and growth rate (2013-2025)

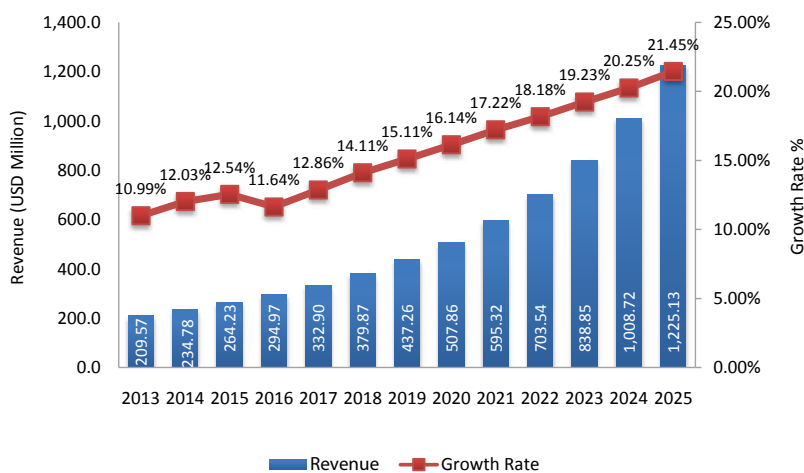

Source : Apex Market Research

In Europe, the growth dynamic also remains strong. LED lighting applications are becoming more usual and this market should take off in 2021.

Europe PoE revenue (USD Million) and growth rate (2013-2025)

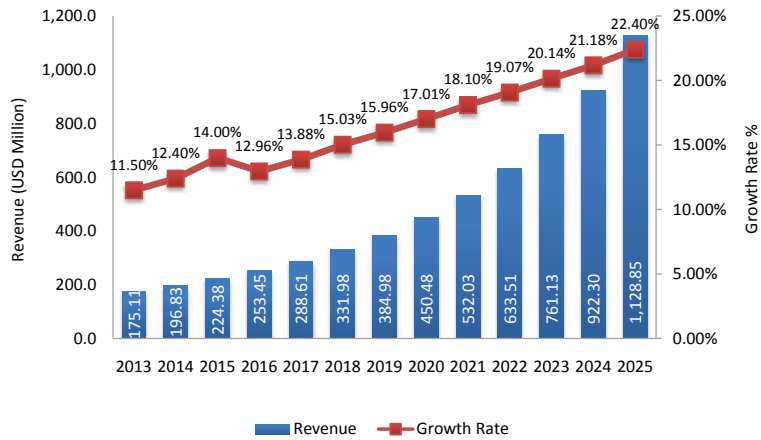

Source : Apex Market Research

PoE market consumption revenue (USD Million) comparison by regions (2013-2025).

PoE market consumption revenue (USD Million) comparison by regions (2013-2025)

Region	2013	2018	2025	Market Share (%) 2025	CAGR (%) (2018-2025)
North America	209.57	379.87	1 225.13	37.54%	18.21%
Europe	175.11	331.98	1 128.85	34.59%	19.11%
Asia Pacific	88.45	178.78	668.37	20.48%	20.73%
South America	19.89	38.47	123.68	3.79%	18.16%
Middle East & Africa	18.25	32.60	117.49	3.60%	20.10%
Total	511.28	961.70	3 263.53	100%	19.07%

Source : Apex Market Research

Conclusion and prospects

PoE technology concerns all sectors: construction, industry and telecommunications. IP convergence and digitalisation of our daily environment are acting as an accelerator and some applications such as LED lighting or indoor mobile coverage will further amplify this phenomenon. This is why this technology keeps gaining popularity, with foreseeable growth rates of 20% (between 2018 and 2025).

#smartconnection

Connect via **LinkedIn**



Learn more on **YouTube**

Visit **www.aginode.net**

Contact us via
info@aginode.net

www.aginode.net

